

Beast Academy 4

Chapter 1: Shapes

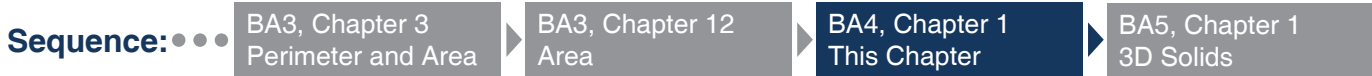

This chapter is part of the Geometry sequence. Before starting, students should have a solid foundation with basic shape classification and naming conventions learned in BA3, Chapter 1.

The Shapes chapter can be difficult for students, particularly if this is their first time using Beast Academy. It can be moved to any point in the BA4 sequence. **It does not need to come first.**

Overview

The same way that understanding numbers and place value is critical to students' early work in arithmetic, understanding the fundamental building blocks of geometry (point, line, segment, etc.), helps students learn how these shapes can be combined into more complex figures later on.

Students learn to measure angles, add new terms to their vocabularies (with clear, rigorous, mathematical definitions), and are introduced to the concept of symmetry.

Definitions

Students should be able to recognize basic geometric figures like line, point, plane, segment, ray, etc., and understand geometric terms. They do not need to memorize these definitions and we recommend students be allowed to reference them as needed.

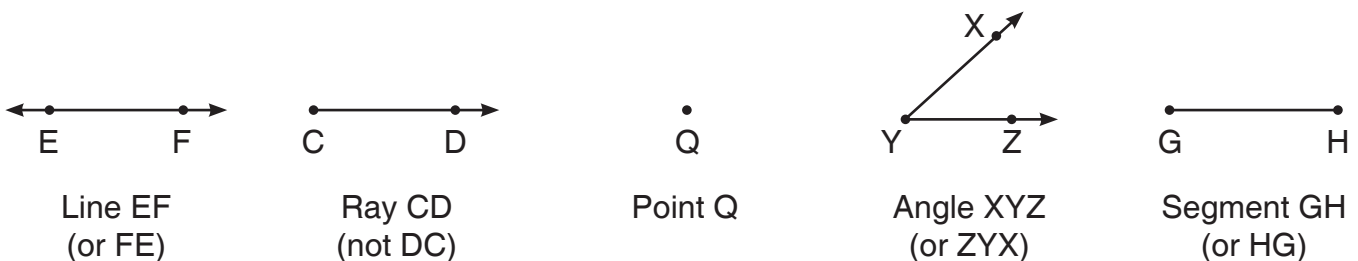

Angle Measurement

Using a protractor is difficult. While we'd like students to be able to measure angles accurately, it's more important that students gain "angle sense." Encourage students to estimate angle measures within 10 or 15 degrees using benchmark angles like 90° , 45° , and 180° . This will help students recognize which of the two sets of numbers on the protractor to use when measuring.

Students should also recognize that angle measures are additive. For example, in the diagram, there are three angles (DBA, ABC, and DBC). Students should be able to use the measure of any two of these angles to find the third using addition or subtraction.

Understanding how figures can be built from or broken down into smaller pieces is how many geometry problems are solved.

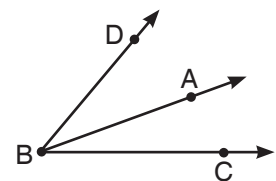

Beast Academy 4

Chapter 1: Shapes

Classifying Shapes (an important note about trapezoids)

Trapezoids require some explanation, and lead to an important point about classification.

Many curricula use what we believe is a flawed definition of trapezoid. They define trapezoid as a quadrilateral with *exactly* one pair of parallel sides. **The widely accepted mathematical definition defines a trapezoid as having *at least* one pair of parallel sides. This is the definition we use.**

This definition is consistent with all of the other definitions we've used.

For example, a rectangle is a quadrilateral with four right angles. Since a square has four right angles, a square is a special type of rectangle (but it's still a rectangle). A rectangle does not stop being a rectangle just because it has four *equal* sides.

Similarly, a trapezoid should not stop being a trapezoid simply because it has *two* pairs of parallel sides. By our definition, every parallelogram is a special type of trapezoid.

Good classifications describe a category without making “holes” by excluding special cases.

With our definition, the shapes below are all trapezoids (since they are all quadrilaterals with at least one pair of parallel sides). Several have more descriptive names (like parallelogram, rhombus, rectangle, or square), but they are all still trapezoids.



Unfortunately, since there is not universal agreement on the definition of trapezoid, you may need to consult your local standards to make sure your students don't outsmart their tests.

Symmetry

Recognizing symmetry takes practice. In this section, students gain agility with mental rotations and reflections and build pattern recognition when looking at geometric figures.

Being able to recognize symmetries will help students understand relationships like the ones below.

Symmetry can help students recognize congruent shapes.

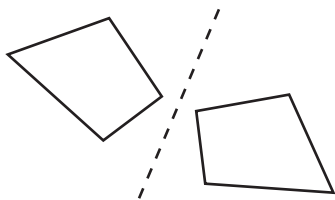

Rotational symmetry helps students see the 1/2 relationship between triangle and quadrilateral area.

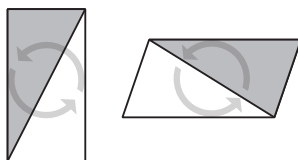

When a line crosses parallel lines, we get pairs of equal angles, which we see with rotational symmetry.

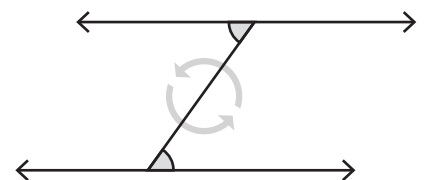

Beast Academy 4

Chapter 2: Multiplication

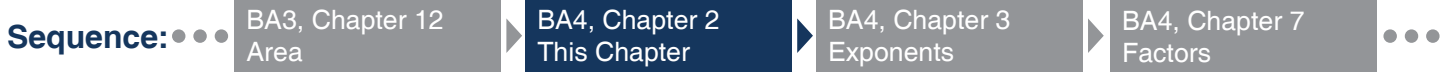

Students beginning this chapter must be fluent with their 1-digit multiplication facts, and should be able to quickly compute products ending in zeros (e.g., $90 \times 200 = 18,000$ and $50 \times 80 = 4,000$).

Students should also have a solid understanding of the distributive property (even if they don't know what it's called). We have a whole chapter on the Distributive Property in BA3, Chapter 6.

Overview

Teaching multiplication as a series of steps, of “carrying ones” and “bringing down zeros” doesn't help students understand multiplication. Students rarely know *why* performing these steps works.

We don't recommend teaching any algorithm that students can use without being able to explain why they are doing each step. Students who learn steps without meaning have trouble remembering them, and can't tell when they've made mistakes, since nothing they are doing makes any sense to them.

Instead, focus on helping students *understand* multiplication using the models explained below.

The Distributive Property

The distributive property is the foundation of all the multiplication models we use.

Guide students to see that three 456's is three 400's plus three 50's plus three 6's. That's the distributive property!

Compute 3×456 .

$$\begin{aligned}
 3 \times 456 &= 3 \times (400 + 50 + 6) \\
 &= (3 \times 400) + (3 \times 50) + (3 \times 6) \\
 &= 1,200 + 150 + 18 \\
 &= \mathbf{1,368}
 \end{aligned}$$

The Area Model

The area model of multiplication works great as an organizational tool and is a great visual representation of the distributive property.

We are breaking multi-digit multiplication into partial products, then adding them to give a final product.

The area model is especially helpful for introducing 2-by-2-digit multiplication (see below), where the work requires more organization and it's harder to keep track of the partial products.

Compute 3×456 .

	400	50	6	
3	1,200	150	18	1,200 150 + 18 <hr/> 1,368

So, $3 \times 456 = \mathbf{1,368}$.

$$\begin{aligned}
 16 \times 28 &= (10 + 6) \times (20 + 8) \\
 &= (10 \times 20) + (10 \times 8) + (6 \times 20) + (6 \times 8) \\
 &= 200 + 80 + 120 + 48 \\
 &= \mathbf{448}
 \end{aligned}$$

Compute 16×28 .

	20	8	
10	200	80	200 120 80 + 48 <hr/> 448
6	120	48	

So, $16 \times 28 = \mathbf{448}$.

Beast Academy 4

Chapter 2: Multiplication

The Partial Products Algorithm

Once students understand how to split multi-digit multiplication into partial products, they can learn to organize their work efficiently.

The method we recommend requires more writing than the traditional stacking algorithm shown below, but **students can understand what's happening in each step, and why it works.**

Compute 56×78 .

Encourage This

Stack the two numbers, lining up the digits.

Distributing gives four partial products: $8 \times 6 = 48$, $8 \times 50 = 400$, $70 \times 6 = 420$, and $70 \times 50 = 3,500$.

Finally, add the partial products.

$\begin{array}{r} 56 \\ \times 78 \\ \hline \end{array}$	$\begin{array}{r} 56 \\ \times 78 \\ \hline 48 \\ \hline \end{array}$	$\begin{array}{r} 56 \\ \times 78 \\ \hline 48 \\ 400 \\ \hline \end{array}$	$\begin{array}{r} 56 \\ \times 78 \\ \hline 48 \\ 400 \\ 420 \\ \hline 3,500 \\ \hline \end{array}$	$\begin{array}{r} 56 \\ \times 78 \\ \hline 48 \\ 400 \\ 420 \\ + 3,500 \\ \hline 4,368 \\ \hline \end{array}$
--	---	--	---	--

Not This

Stack the two numbers, lining up the digits.

Multiply $8 \times 6 = 48$. Write the 8, "carry" the 4. Multiply $8 \times 5 = 40$. Add the 4 to get 44 and write that. Bring down a zero.

Multiply $7 \times 6 = 42$. Write the 2, "carry" the 4. Multiply $7 \times 5 = 35$. Add the 4 to get 39 and write that.

Finally, add the two products.

$\begin{array}{r} 56 \\ \times 78 \\ \hline \end{array}$	$\begin{array}{r} 4 \\ 56 \\ \times 78 \\ \hline 8 \\ \hline \end{array}$	$\begin{array}{r} 4 \\ 56 \\ \times 78 \\ \hline 448 \\ 0 \\ \hline \end{array}$	$\begin{array}{r} 4 \\ 56 \\ \times 78 \\ \hline 48 \\ 448 \\ 20 \\ \hline \end{array}$	$\begin{array}{r} 4 \\ 4 \\ 56 \\ \times 78 \\ \hline 448 \\ 3,920 \\ \hline \end{array}$	$\begin{array}{r} 4 \\ 4 \\ 56 \\ \times 78 \\ \hline 448 \\ + 3,920 \\ \hline 4,368 \\ \hline \end{array}$
--	---	--	---	---	---

Teaching Algorithms

Teaching an algorithm that doesn't promote understanding can do far more harm than good.

Students who are taught to view math as a set of processes and formulas often shut down when asked to solve an unfamiliar problem.

Our goal is to help students understand math in a way that helps them become resilient problem solvers who can apply what they've learned to a variety of problems.

Even the recommended algorithm above should only be used when necessary. For example, encourage students to compute 8×103 mentally as $800 + 24 = 824$, rather than stacking the numbers, writing out the partial products, then finding the sum.

Beast Academy 4

Chapter 3: Exponents

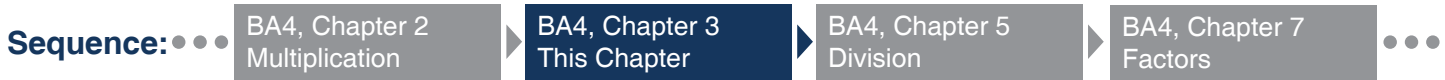

Students should be fluent with multiplication, perfect squares, and the order of operations (using parentheses, multiplication & division, and addition & subtraction) before beginning this chapter.

Overview

Exponents are a shortcut for writing repeated multiplication. Students should begin by writing out expressions that include exponents as repeated multiplication.

Encourage students to reason their way through problems using what they know about exponents. “For $3^4 \times 3^7$, I am multiplying a total of $4+7 = 11$ threes. So, $3^4 \times 3^7 = 3^{11}$.”

Avoid teaching students to memorize and apply formulas like $a^m \cdot a^n = a^{m+n}$. Students who can reason through problems are likely to discover these formulas on their own and apply them correctly.

Basics

We can write the product $2 \times 2 \times 2 \times 2 \times 2$ as 2^5 . The expression 2^5 is called a **power** of 2 and is read “2 to the 5th power.”

In the expression 2^5 , the 2 is the **base**. The base is the number we multiply repeatedly. The 5 is called the **exponent**. The exponent tells us how many of the base we multiply.

Practice writing repeated multiplication using exponents ($3 \times 3 \times 3 \times 3 = 3^4$), and powers as multiplication ($7^3 = 7 \times 7 \times 7$).

Have students evaluate powers using multiplication ($5^4 = 5 \times 5 \times 5 \times 5 = 625$) and evaluate nearby powers using a known power as shown on the right. Students who understand exponents will see that 2^9 is $2^8 \times 2$.



$$2^5 = 2 \times 2 \times 2 \times 2 \times 2$$

If $2^8 = 256$, what is 2^9 ?

$$\begin{aligned} 2^9 &= (2 \times 2 \times 2 \times 2 \times 2 \times 2 \times 2 \times 2) \times 2 \\ &= (2^8) \times 2 \\ &= 256 \times 2 \\ &= 512 \end{aligned}$$

Students can also multiply powers with the same base. Start with powers that have small exponents where students can write out all of the multiplication. $5^4 \times 5^3 = (5 \times 5 \times 5 \times 5) \times (5 \times 5 \times 5) = 5^7$.

Then, they can reason through problems with larger exponents without writing out the multiplication.

Write $11^{12} \times 11^{13}$ as a power of 11.

Encourage This

$$11^{12} \times 11^{13} = \underbrace{(11 \times 11 \times \dots \times 11)}_{12 \text{ evens}} \times \underbrace{(11 \times 11 \times \dots \times 11)}_{13 \text{ evens}}$$

Multiplying $11^{12} \times 11^{13}$ gives a product of $12+13 = 25$ evens. So, $11^{12} \times 11^{13} = 11^{25}$.

Not This

Use the formula $a^m \cdot a^n = a^{m+n}$.

When we multiply two powers that have the same base, we add their exponents.

So, $11^{12} \times 11^{13} = 11^{12+13} = 11^{25}$.

Beast Academy 4

Chapter 3: Exponents

Order of Operations

The order of operations tells us how to evaluate an expression. Students should have already practiced with expressions that have parentheses, multiplication & division (working from left-to-right), and addition & subtraction (also done in order from left to right).

Exponents should be evaluated before multiplication and division in the order of operations.

We avoid mnemonics like “PEMDAS.” Too many students assume that this means multiplication comes before division and addition comes before subtraction.

Manipulating Expressions with Exponents

Perfect Squares

Have students try to write powers as perfect squares. Students should start by writing powers with small exponents as multiplication, then splitting the numbers into two equal groups. With practice, they can reason their way through working with powers that have larger exponents.

This will help students recognize perfect squares later using a number’s prime factorization.

Write 7^4 as a perfect square.

$$\begin{aligned}7^4 &= 7 \times 7 \times 7 \times 7 \\ &= (7 \times 7) \times (7 \times 7) \\ &= 49 \times 49 \\ &= 49^2\end{aligned}$$

Equivalent Expressions

Students can practice writing other expressions that are equal (for example, converting 49^2 back to 7^4).

The goal is for students to practice manipulating expressions that include exponents. For example, students should recognize that $(3 \times 5)^4$ is the product of four 3’s and four 5’s, which can be written as $3^4 \times 5^4$.

Later, they will use many of the same strategies for factoring and working with more complex expressions.

Write $2^6 \times 3^3$ as a power of 12.

$$\begin{aligned}2^6 \times 3^3 &= (2 \times 2 \times 2 \times 2 \times 2 \times 2) \times (3 \times 3 \times 3) \\ &= (2 \times 2 \times 3) \times (2 \times 2 \times 3) \times (2 \times 2 \times 3) \\ &= 12 \times 12 \times 12 \\ &= 12^3\end{aligned}$$

Binary

In our standard base-10 number system, we have ten digits (0-9). The place values are powers of ten: ones (10^0), tens (10^1), hundreds (10^2), thousands (10^3), etc.

Binary (base-2) numbers use just two digits (0 and 1). The place values for binary numbers are powers of 2: ones (2^0), twos (2^1), fours (2^2), eights (2^3), etc.

This is a topic you are unlikely to find in any other curriculum. It’s a lot of fun, and learning place value in another system is a great way for students to gain a deep understanding of how our standard base-10 numbers work.

Write thirteen in binary (base-2).

The five smallest place values in base-2 are shown below. Since thirteen is less than sixteen, it is a four-digit number in binary. To make thirteen, we need 1 eight, 1 four, and 1 one.

$$\begin{array}{rcccc} & 1 & 1 & 0 & 1 \\ \hline \text{Sixteens} & \text{Eights} & \text{Fours} & \text{Twos} & \text{Ones} \end{array}$$

So, in binary, thirteen is 1,101.

Beast Academy 4

Chapter 4: Counting



Sequence:

BA4, Chapter 4
This Chapter

BA4, Chapter 12
Probability

Counting is a topic in discrete math that is rarely taught at this level. However, it's a lot of fun and requires careful thought and lots of problem solving strategies, so we encourage everyone with time to tackle the math in this chapter. Many of these strategies are used in other parts of the BA curriculum.

Overview

Counting is a lot trickier than the name implies. In this chapter, we introduce skills that are valuable in many areas of math, ranging from probability to statistics to computer science.

More importantly, counting is a fun and approachable topic that requires careful thought, organization, experimentation, and other problem solving strategies.

Counting Lists

How many pages will you read if you start on page 1 and finish on page 10? Most students will correctly answer "10".

How many pages will you read if you start on page 30 and finish on page 50? Many students will wrongly subtract $50 - 30 = 20$. (The correct answer is 21.)

Off-by-1 errors are among the most common mistakes in math, and this section helps students recognize potential errors.

The goal in this section is to help students turn lists like the second into lists like the first (that start at 1 and count by 1's) using addition, subtraction, and division. Changing the numbers in a list does not change how many numbers there are, but it makes the list easy to count.

How many pages will you read if you start on page 30 and end on page 50?

$$\begin{array}{r} 30, 31, 32, \dots, 48, 49, 50. \\ -29 \quad -29 \quad -29 \quad \dots \quad -29 \quad -29 \quad -29 \\ \hline 1, 2, 3, \dots, 19, 20, 21. \end{array}$$

Subtracting 29 from every page number on the list from 30-50 gives us a list from 1-21, which has 21 numbers.

Possibilities (Tree Diagrams)

Counting possibilities requires careful organization. Start with problems that are easy to complete with an organized list before introducing students to tree diagrams, where each branch represents a possibility.

Encourage students to create their own tree diagrams for different problem types before using multiplication to count possibilities.

Sandwiches come on white or wheat bread with a choice of one meat (ham, salami, or bologna). How many possible sandwiches are available?

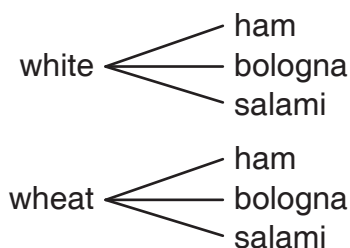

There are 6 possible sandwiches: ham on white, bologna on white, salami on white, ham on wheat, bologna on wheat, and salami on wheat.

Beast Academy 4

Chapter 4: Counting

Possibilities (Multiplication)

After working with tree diagrams to count possibilities, encourage students to look for shortcuts. “What if there were 4 choices of meat?” “What if there were 14 choices of meat?”

Many will notice that the number of choices at each step can be multiplied to give the total number of possibilities. For example, in our sandwich problem, if there were 5 bread choices, 7 meat choices, and 3 available sizes, this would give $5 \times 7 \times 3 = 105$ possible sandwiches (which would be a real pain to draw the tree diagram for).

Venn Diagrams

Venn diagrams are useful for organizing things that are in overlapping categories.

Have students learn how Venn diagrams work by helping them create their own. For example, draw overlapping circles to represent students who have black hair and students who have glasses (choose whatever categories work best). Students can write names of classmates in the correct part of the diagram.

Help students recognize that items can be counted in multiple categories. For example, in the diagram on the right, there are 3 months that start with “J”, 4 that end in “y”, 2 that do both, and 7 that don’t do either (but there are not $3 + 4 + 2 + 7 = 16$ months). Some items get counted more than once.

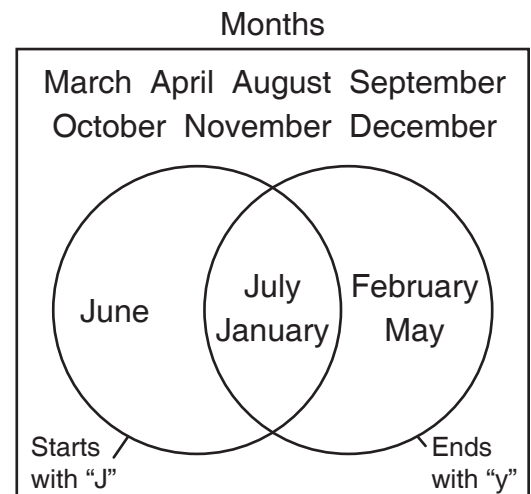

Arrangements

Students who understand how to count possibilities using multiplication can count arrangements using similar logic.

For example, we can count the number of ways Amy, Ben, Cole, and Denise can place 1st through 4th in a race using multiplication (eliminating the need for the painful tree diagram on the left).

Careful! There are not $4 \times 4 \times 4 \times 4$ possibilities.

There are 4 students who can finish first.

This leaves 3 students who can finish second.

This leaves 2 students who can finish third.

The 1 remaining student is last.

So, there are $4 \times 3 \times 2 \times 1 = 24$ orders for the students to finish the race.

The short way to write $4 \times 3 \times 2 \times 1$ is $4!$, which is called a **factorial**.

How many ways can Amy, Ben, Cole, and Denise place 1st through 4th in a race?

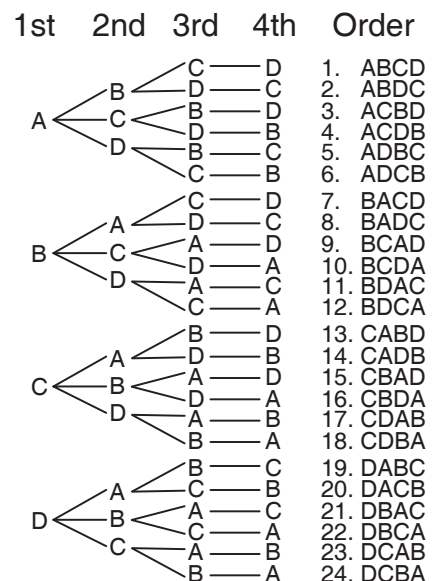

Beast Academy 4

Chapter 5: Division

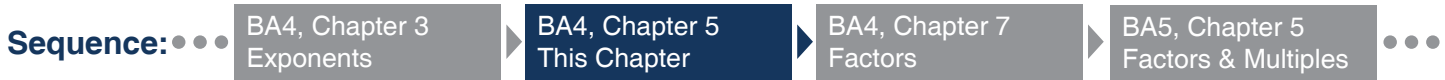

Before beginning this chapter, students should understand the relationship between multiplication and division, and be comfortable finding quotients and remainders as taught in BA3, Chapter 8.

Overview

Students extend the division skills learned in BA3 to larger numbers and learn some new division strategies and divisibility tests.

Special Quotients

Lead a discussion to help students make generalizations about some special cases in division.

- “What do you get when you divide a number by 1?” (You get the number.)
- “What if you divide the number by itself?” (You get 1.)
- “What do you get when you divide zero by a number?” (You get zero.)
- “What if you divide a number by zero?” (That doesn’t make sense!)

The last case is the most difficult. Mathematicians call results that don’t make sense “undefined”.

Dividing multiples of 10

When dividing numbers that end in one or more zeros, it is useful to relate the concept of division to multiplication. For example, to divide 3,600 by 90, students can fill the blank in $90 \times \underline{\quad} = 3,600$.

Long Division

We apply the division algorithm from Chapter 8 of Beast Academy 3C to larger numbers.

The goal is that students always understand the steps they are using. Help students reason through division starting with a concrete example.

“If there are 2,868 pennies to split equally into 12 piles, how many pennies will there be in each pile?”

Below is one example of how a student might think through this problem, recording their work as shown on the right. (There are many other ways.)

“I could start by putting **200** pennies in each pile.

That uses a total of $12 \times 200 = 2,400$ pennies.

So, it leaves $2,868 - 2,400 = 468$ pennies to split up.

Next, I could put **30** more pennies in each pile.

That uses a total of $12 \times 30 = 360$ pennies.

So, that leaves $468 - 360 = 108$ pennies.

Putting **5** more pennies in each pile leaves $108 - 60 = 48$ pennies.

Finally, if I put **4** more pennies in each pile, there will be 0 pennies left over. All together, each pile has a total of $200 + 30 + 5 + 4 = 239$ pennies.”

Divide $2,868 \div 12$

$$\begin{array}{r} \overline{) 2,868} \\ \underline{-2,400} \\ 468 \\ \underline{-360} \\ 108 \\ \underline{-60} \\ 48 \\ \underline{-48} \\ 0 \end{array} \left. \begin{array}{l} 4 \\ 5 \\ 30 \\ 200 \end{array} \right\} 239$$

$$2,868 \div 12 = 239$$

Beast Academy 4

Chapter 5: Division

Why do we use the non-traditional algorithm?

Compare the student reasoning in the previous section to the way a student works through the steps of the traditional algorithm below.

12 goes into 28
2 times. I write
a 2 over the 8
and subtract
 $2 \times 12 = 24$ from
28 to get 4.

$$\begin{array}{r} 2 \\ 12 \overline{) 2868} \\ \underline{-24} \\ 4 \end{array}$$

Bring down
the 6.
Next, I divide
12 into 46.

$$\begin{array}{r} 2 \\ 12 \overline{) 2868} \\ \underline{-24} \\ 46 \end{array}$$

12 goes into 46
3 times. I write
a 3 over the 6
and subtract
 $3 \times 12 = 36$ from
46 to get 10.

$$\begin{array}{r} 23 \\ 12 \overline{) 2868} \\ \underline{-24} \\ 46 \\ \underline{-36} \\ 10 \end{array}$$

Bring down
the 8.
Next, I divide
12 into 108.

$$\begin{array}{r} 23 \\ 12 \overline{) 2868} \\ \underline{-24} \\ 46 \\ \underline{-36} \\ 108 \end{array}$$

12 goes into 108
9 times. I write
a 9 on top
and subtract
 $9 \times 12 = 108$ from
108 to get 0.

$$\begin{array}{r} 239 \\ 12 \overline{) 2868} \\ \underline{-24} \\ 46 \\ \underline{-36} \\ 108 \\ \underline{-108} \\ 0 \end{array}$$

The algorithm we use has several advantages over to the one above.

The steps make intuitive sense. The math is not hidden. Students are “taking out” equal groups from 2,868, and keeping track of the total. It is clear to students what is happening at each step.

Another advantage is that students can use multiplication facts they are most comfortable with. In each step of the traditional algorithm above, the student must know the *largest* number of times 12 can go into the number they are dividing.

Using our algorithm, students estimate from the beginning and at each step and are less likely to get a nonsensical answer due to a missed digit or other careless error.

Strategies

Students should look for ways to compute division efficiently without using the division algorithm.

For example, to divide by 4, students can halve a number twice. Apply this to a concrete example like cutting a rope in half, then cutting each half in half.

Students can also split a quotient into parts that are easy to divide.

“How could 63,042 marbles be split into 7 buckets equally?”

Students can split 63,000 marbles first to get $63,000 \div 7 = 9,000$ in each bucket. Then, they can split the remaining 42 marbles to get $42 \div 7 = 6$ more marbles in each bucket. So, $63,042 \div 7$ is $9,000 + 6 = 9,006$. This strategy will help students understand the divisibility rules that follow.

Divisibility

When we can divide one number by another with no remainder, we say that the first number is divisible by the second.

In this chapter, we help students understand divisibility rules for 2, 5, 10, 100, 4, and 25.

Beast Academy 4

Chapter 6: Logic

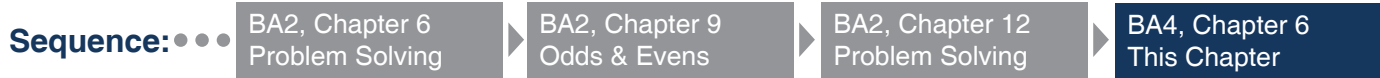

The strategies in this chapter require very few computational skills. So, the chapter can be used at any time in the series or sprinkled throughout BA level 4.

Overview

Taking given information and using it to arrive at a valid conclusion is **logical thinking**.

The goal is for students to use clues to figure out what they know is definitely true. Sometimes this involves figuring out that something else is definitely false.

Being able to think logically and explain your reasoning is an important skill, particularly in mathematics, which is built on logical reasoning.

While this is a chapter that may be considered optional, **it is a lot of fun**, and we encourage all teachers to include at least some of the puzzles and problems in this chapter.

Teaching Logical Reasoning: Take a Step Back.

None of the puzzles or problems in this chapter require any special math skills. Most of the puzzles are accessible to everyone. Teachers should give students space to figure things out on their own.

Resist the urge to do the work for them!

Instead, encourage students to think with lots of questions.

“What have you tried?”

“Why didn’t that work?”

“What did you do next?”

“How do you know?”

“What else can you try?”

This may cause some early frustration. Stay strong! Be patient! Eventually they’ll stop asking you for answers and start thinking on their own. Perfect! You’re doing it right!

Kids will get a lot more out of these problems if they solve them on their own.

Things you *can* do to help:

- Make sure students understand the puzzles. Do some easy examples together to make sure students know what the rules and goals are.
- If the answer to the question “What have you tried?” is, “I don’t remember,” encourage students to get organized. Give them ways to keep track of their work. Simple strategies like “draw an X in a box where you know it *can’t* be” help students keep track of info.
- Don’t be afraid to make mistakes. You can even propose some bad ideas on purpose. This will help students rule stuff out and understand the puzzles better. It also sets the expectation that **students are supposed to experiment and make mistakes**.
- Celebrate variety. Students will find many valid approaches, sometimes ingenious ones! Share these and discuss them, but avoid promoting one “right” way.

Beast Academy 4

Chapter 6: Logic

Logical Reasoning

“Are you sure?”

Help students recognize the difference between a logical conclusion (something they are sure of) and a hunch (something that just ‘feels’ right). For example, given the facts on the left, which of the statements on the right *must* be true? Which *must* be false? Which ones can’t be determined?

Facts:

- Joey is taller than Mia.
- Mia is taller than Raven.
- Raven is shorter than Andre.

Statements:

1. Raven is taller than Joey.
2. Raven is the shortest.
3. Andre is taller than Mia.

We sketch a diagram to organize what we know, drawing arrows from tall to short.

Statement 1: Since Joey is taller than Mia, and Mia is taller than Raven, Joey is definitely taller than Raven. So, statement 1 is false.

Statement 2: We can use the given facts to show that Joey, Mia, and Andre are all taller than Raven. So, Raven is the shortest. Statement 2 is true.

Statement 3: In our first diagram, it looks like Andre is taller than Mia. But are we *sure*? We know that Andre and Mia are both taller than Raven, but we don’t have any information to compare Andre and Mia. We could have drawn Andre *anywhere* above Raven. So, statement 3 can’t be determined.

Students might offer “evidence” like, “A is above M in my diagram,” or just, “Andre seems taller.” Help students learn to support their conclusions using only what they know for sure.

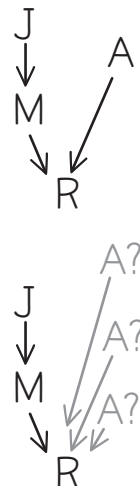

Tipping Over The First Domino

For many of the puzzles in this chapter, the hardest part is getting started. This is where you use your questioning strategies. Once they’ve found a place to start, encourage students to use what they’ve figured out to reach other conclusions. For example, in the Minesweeper puzzle below, each number gives the number of mines that are in the empty squares that surround it. The goal is to figure out where all of the mines are. Encourage to find a good place to start, then look for what to do next.

Solve the following Minesweeper puzzle.

	2		
			3
4	5		
			2

There is only one way to place 4 mines around the 4.

	2		
●	●		3
4	5		
●	●		2

There can’t be any more mines around the 2 at the top.

×	2	×	
●	●	×	3
4	5		
●	●		2

Now there is only one way to place 3 mines around the 3.

×	2	×	●
●	●	×	3
4	5	●	●
●	●		2

And the last square can’t have a mine, so we’re done!

×	2	×	●
●	●	×	3
4	5	●	●
●	●	×	2

“Aha!” moments and chain reactions make problems like this a lot of fun for students and help them learn to reason through all sorts of problems they’ll encounter.

Beast Academy 4

Chapter 7: Factors

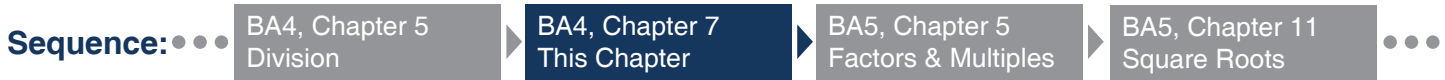

Students should have their multiplication facts mastered before beginning this chapter. Students should also know divisibility rules from the BA4 division chapter (rules for 2, 4, 5, 10, 25, and 100).

Overview

Factoring is an essential skill that students will use in a variety of situations, from simplifying fractions to working with polynomials in algebra.

Practice with factoring and prime factorization is a great way to improve students' number sense.

Factor Basics

Factors of n are the numbers that n is divisible by. Help students understand the relationship between factors and multiples. For example, factors of 35 are 1, 5, 7, and 35, which also means that 35 is a multiple of 1, 5, 7, and 35.

Encourage students to find factors in an organized way, working in pairs and starting with the smallest. To find all the factors of 40, a student can start with 1×40 , then 2×20 , then (recognizing that 3 is not a factor) moving on to 4×10 and 5×8 .

Next, 6 and 7 are not factors. Since $7 \times 7 = 49$, any number that is 7 or greater would have to be paired with a smaller factor. Since we've checked all of the factors smaller than 7, we're done!

List all factors
of 40 and of 51.

<u>40:</u>	<u>51:</u>
1×40	1×51
2×20	3×17
4×10	
5×8	

Primes and Composites

A number with *exactly* two factors (one and itself) is called a **prime** number. A number with more than 2 factors is called **composite**. 0 and 1 are neither prime nor composite.

Students should start to recognize all of the smaller primes (2, 3, 5, 7, and 11). To find every prime under 100, we cross out all of the *composite* numbers from 2 to 100 on a hundreds chart. Every number that's left is prime.

Read through the Gym section of the Guide to help students understand this process. Start by crossing out multiples of 2 (except 2), then multiples of 3 (except 3). Ask students why they don't need to cross out multiples of 4 (those were crossed out when we crossed out the multiples of 2), or 11 (we already crossed out all of the multiples of 11 that are less than 100 since we crossed out every multiple of 2, 3, 4, 5, 6, 7, 8, 9.)

Students can use these charts later to check whether a number is prime or not (51 and 91 are particularly tricky).

In the hundreds chart below, every prime is circled, and every composite is crossed out.

	2	3	4	5	6	7	8	9	10
11	12	13	14	15	16	17	18	19	20
21	22	23	24	25	26	27	28	29	30
31	32	33	34	35	36	37	38	39	40
41	42	43	44	45	46	47	48	49	50
51	52	53	54	55	56	57	58	59	60
61	62	63	64	65	66	67	68	69	70
71	72	73	74	75	76	77	78	79	80
81	82	83	84	85	86	87	88	89	90
91	92	93	94	95	97	98	99	100	

Beast Academy 4

Chapter 7: Factors

Divisibility

Students should be able to recognize whether a number is divisible by 2 (if it's even), 4 (if it ends in a 2-digit multiple of 4), 5 (if it ends in 0 or 5), 10 (if it ends in 0), and possibly other patterns that help them check for divisibility.

We give a few more useful tools for checking divisibility.

Encourage students to split a number into parts. For example, to see whether 42,040 is divisible by 7, students should see that 42,000 is divisible by 7 ($7 \times 6,000$), but 40 is not. So, 42,040 is *not* divisible by 7 (but both 42,035 and 42,042 are).

We also explain divisibility tests for 3 and for 9. The “why” behind these rules is tough, but we encourage you to work through the R&G section of the Guide to help students understand why these rules work. This is an instance where it is acceptable if many students learn the rule without fully understanding it.

Prime Factorization

Every number has its own unique prime factorization. We usually write a number's prime factorization using exponents with the factors listed in order. For example, $54 = 2 \times 3^3$, and $60 = 2^2 \times 3 \times 5$. The prime factorization of a prime is the number itself ($71 = 71$).

Factor trees help students find a number's prime factorization. Discuss (don't discourage) various factor trees for the same number that give the same prime factorization.

Testing for primes is tricky. How can a student tell whether 127 is prime? Encourage students to be organized and efficient when checking for factors, and know how to tell when they're done.

To see if 127 is prime, we test 2, then 3, then 5. None are factors of 127. Ask, “Why don't we need to test composite numbers like 4 and 6?” If 4 were a factor, 2 would be, too. If 6 were a factor, 2 and 3 would both be factors. **So, we only need to check if primes are factors.** Next, we test 7 and 11. Neither is a factor of 127.

Ask, “Why don't we need to test 13? Or 17? Or 19?” If 13 (or 17, or 19) were a factor of 127, then it would have to be paired with a factor that is smaller than 13, since $13 \times 13 = 169$. We already tested all of the primes below 13, and no prime less than 13 is a factor of 127, so 127 is prime!

We can do all sorts of great things with a number's prime factorization. For example, we can tell that 51 (3×17) is a factor of 9,996 ($2^2 \times 3 \times 7^2 \times 17$), since 9,996 has $3 \times 17 = 51$ in its prime factorization.

Divisibility rule for 3:

If the sum of a number's digits is divisible by 3, then the number is divisible by 3.

For example, since $4 + 1 + 8 + 2 = 15$, 4,182 is divisible by 3.

Divisibility rule for 9:

If the sum of a number's digits is divisible by 9, then the number is divisible by 9.

For example, since $4 + 0 + 9 + 5 = 18$, 4,095 is divisible by 9.

Use a factor tree to find the prime factorization of 196.

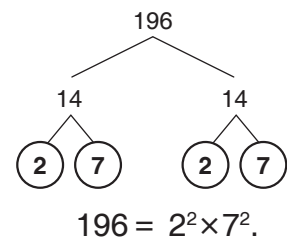

Is 127 prime?

Divisibility tests tell us that 2, 3, and 5 are not factors of 127. $7 \times 18 = 126$, so 7 isn't a factor. $11 \times 11 = 121$, so 11 isn't.

So, 127 is prime.

Is $51 = 3 \times 17$ a factor of $9,996 = 2^2 \times 3 \times 7^2 \times 17$?

$$\begin{aligned} 9,996 &= (3 \times 17) \times (2^2 \times 7^2) \\ &= 51 \times (2^2 \times 7^2) \end{aligned}$$

So, 51 is a factor of 9,996.

Beast Academy 4

Chapter 8: Fractions (+&-)

Sequence:

BA3, Chapter 10
Fractions

BA4, Chapter 8
This Chapter

BA4, Chapter 10
Fractions

BA4, Chapter 11
Decimals



Students **must** have a solid understanding of fractions and fraction notation from BA3, Chapter 10 before beginning this chapter.

Overview

This chapter introduces adding and subtracting fractions and mixed numbers with the same denominator.

Focus on fractions as **numbers on the number line**. When students think of fractions as numbers (and not just as parts of a whole), they can apply strategies they've used with whole numbers, like the counting-up strategy for subtraction shown on the right.

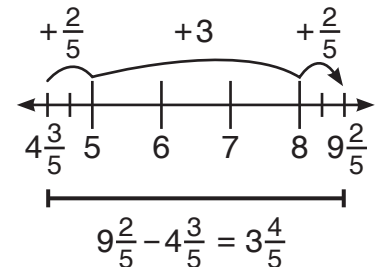

Adding and Subtracting Fractions

Relate fraction addition and subtraction to the computations students already know. Adding 3 pencils and 2 pencils equals 5 pencils. Adding 3 sevenths plus 2 sevenths equals 5 sevenths.

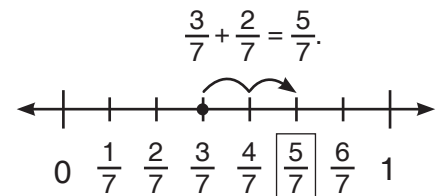

Mixed Number Conversions

Avoid teaching an algorithmic approach to conversions. Instead, encourage students to reason through conversions using what they know about fractions.

Encourage This

$4\frac{2}{5}$ is $4 + \frac{2}{5}$, and 4 is $\frac{20}{5}$.

So, $4\frac{2}{5} = \frac{20}{5} + \frac{2}{5} = \frac{22}{5}$.

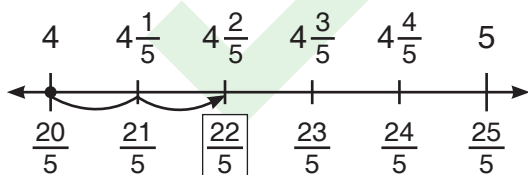

Similarly, $\frac{22}{5} = \frac{20}{5} + \frac{2}{5} = 4 + \frac{2}{5} = 4\frac{2}{5}$.

Not This

$4\frac{2}{5}$

1. Multiply the whole number by the denominator. 1. $4 \times 5 = 20$
2. Add the numerator to this result. 2. $20 + 2 = 22$
3. Put your final result over the original denominator. 3. $\frac{22}{5}$

Beast Academy 4

Chapter 8: Fractions

Breaking and Regrouping

Students should understand that they can **break** the whole number part of a mixed number to make a subtraction problem easier.

Students should also be able to do the opposite and **regroup** the fraction part of a mixed number to write final answers.

$$3\frac{1}{5} = 2 + \frac{5}{5} + \frac{1}{5} = 2\frac{6}{5}$$

$$2\frac{6}{5} = 2 + \frac{5}{5} + \frac{1}{5} = 3\frac{1}{5}$$

Adding and Subtracting Mixed Numbers

For addition, encourage students to add the whole numbers and fractions separately, then regroup. For subtraction, encourage students to break a whole into parts to make the subtraction easier. This is almost always better than converting mixed numbers to fractions before adding or subtracting.

Encourage This

$$\begin{aligned} 6\frac{5}{7} + 2\frac{4}{7} &= \left(6 + \frac{5}{7}\right) + \left(2 + \frac{4}{7}\right) \\ &= (6+2) + \left(\frac{5}{7} + \frac{4}{7}\right) \\ &= 8 + \frac{9}{7} \\ &= 9\frac{2}{7}. \end{aligned}$$

$$\begin{array}{r} 6\frac{4}{7} \\ -2\frac{6}{7} \\ \hline \end{array} \rightarrow \begin{array}{r} 5\frac{11}{7} \\ -2\frac{6}{7} \\ \hline 3\frac{5}{7} \end{array}$$

We do not expect students to show work this way. This is the thought process we'd like students to be using. Many steps can be done in their heads.

Not This

$$\begin{aligned} 6\frac{5}{7} + 2\frac{4}{7} &= \left(\frac{6 \times 7 + 5}{7}\right) + \left(\frac{2 \times 7 + 4}{7}\right) \\ &= \frac{47}{7} + \frac{18}{7} \\ &= \frac{65}{7} \\ &= 9\frac{2}{7}. \end{aligned}$$

$$\begin{aligned} 6\frac{4}{7} - 2\frac{6}{7} &= \left(\frac{6 \times 7 + 4}{7}\right) - \left(\frac{2 \times 7 + 6}{7}\right) \\ &= \frac{46}{7} - \frac{20}{7} \\ &= \frac{26}{7} \\ &= 3\frac{5}{7}. \end{aligned}$$

Computation Strategies

We can use the same strategies we use with whole numbers when adding and subtracting mixed numbers and fractions. Examples are given below.

Clever Regrouping.

$$\begin{aligned} 10\frac{8}{9} + \frac{5}{9} &= 10\frac{8}{9} + \left(\frac{1}{9} + \frac{4}{9}\right) \\ &= \left(10\frac{8}{9} + \frac{1}{9}\right) + \frac{4}{9} \\ &= 11\frac{4}{9} \end{aligned}$$

Subtract then add.

$$\begin{aligned} 4\frac{1}{9} - 2\frac{8}{9} &= 4\frac{1}{9} - 3 + \frac{1}{9} \\ &= 1\frac{1}{9} + \frac{1}{9} \\ &= 1\frac{2}{9}. \end{aligned}$$

Make easy sums.

$$\begin{aligned} \frac{1}{7} + \frac{3}{7} + \frac{4}{7} + \frac{6}{7} &= \left(\frac{1}{7} + \frac{6}{7}\right) + \left(\frac{3}{7} + \frac{4}{7}\right) \\ &= 1 + 1 \\ &= 2. \end{aligned}$$

Beast Academy 4

Chapter 9: Integers



Sequence: BA4, Chapter 9
This Chapter

BA5, Chapter 2
Integers

Overview

An **integer** is a number without a fractional part. This is the first chapter in Beast Academy where negative numbers are used. Students will learn to compare, add, and subtract negative integers.

Basics

We introduce integers on the number line. Positive integers are to the right of zero. Negative integers are to the left of zero.

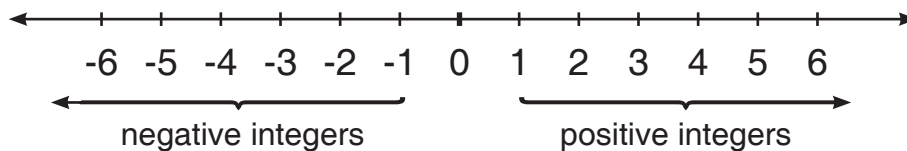

When comparing two numbers on the number line, the number on the left is always less than the number on the right. So, -8 is *less* than -5. This can be a hard idea for students to get behind.

Most students have seen negatives used to describe temperatures, and probably recognize that -8 degrees is colder than -5 degrees. Temperature is a great way to connect integers to a concept most students are familiar with. Apologies to our equatorial readers. You're on your own.

We call numbers that are the same distance from zero like 6 and -6 **opposites**.

Addition

Students can figure out how to add positives and negatives using what they already know about addition on the number line. Start by modeling addition like $3+5$ on a number line and ask students questions like "Where do I start? Which way do I go? How far?"

Adding a positive number.

To add 3 to a number, we start at the number and move 3 units to the right. Adding $-8+3$ works the same way. We start at -8 and move 3 units to the right. So, $-8+3 = -5$.

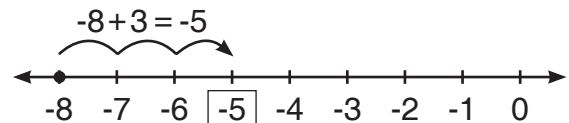

Adding a negative number.

When we add a positive number, we move to the right. To add a negative, we do the opposite; we move to the left. For $3+(-8)$, we start at 3 and move 8 units to the left. We get to -5.

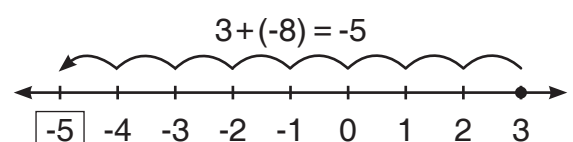

$3+(-8)$ gives the same answer we got when we added $-8+3$, which makes sense, since addition is commutative!

Beast Academy 4

Chapter 9: Integers

Addition (continued)

Mix in adding a negative to a negative. To compute $-3+(-4)$, we start at -3 and move 4 units to the left.

Include a variety of problems. Make sure to use problems where students cross zero like $-3+9$ and $5+(-9)$, as well as problems where students don't cross zero like $-9+6$ and $5+(-2)$.

Move on to problems where students can't easily mark every number on the number line. For example, to solve $-38+25$, students can sketch the number line on the right. Eventually, they can reason without the visual aid. "Starting at -38 , I move 25 units closer to zero. I end up $38-25 = 13$ units left of zero at -13 . So, $-38+25 = -13$."

Students may notice some patterns and try to make rules. For example, "When I add two negatives, the result is always negative."

Challenge students to explain patterns they find. "Are you sure that always works?" "Why?"
However, avoid teaching integer operations as a set of rules to memorize.

For example, "When adding integers, if the signs are different, subtract the numbers and use the sign of the bigger number." That rule describes what a lot of us do without thinking about it. But it's nonsense to students new to integer addition.

Students who try to memorize rules without making sense of them are likely to fail, especially when they move on to multiplication and division where a rule like "Adding two negatives always gives a negative" is easily confused with "Multiplying two negatives always gives a positive."

But, with practice, students should begin to apply these patterns automatically and without thinking about the number line. For example, students should recognize that adding a bunch of negatives like $(-5)+(-5)+(-5)+(-5)+(-5)$ gives us a result that is more negative (-25), but when adding positives and negatives as in $(-5)+5+(-5)+5+(-5)$, the opposites 'cancel', giving us -5 .

Subtraction

Subtracting positives and negatives.

Start students with examples they know, like $7-5$, $7-6$, and $7-7$. Students should see that $7-8 = -1$. They can move on to problems that start with a negative like $-4-5$, practicing on the number line as they did with addition. Then, ask students to guess what we do to subtract a negative.

To subtract a positive number, we move left down the number line.

To subtract a negative number, we do the opposite; we move *right* up the number line.

Hopefully students will realize on their own that subtracting a negative is the same as adding a positive. This brings us to a very important rule that we actually encourage you to teach.

To subtract a number, add its opposite.

This is actually how mathematicians define subtraction. It's really useful to think of subtraction as adding the opposite, since we can rearrange addition however we'd like.

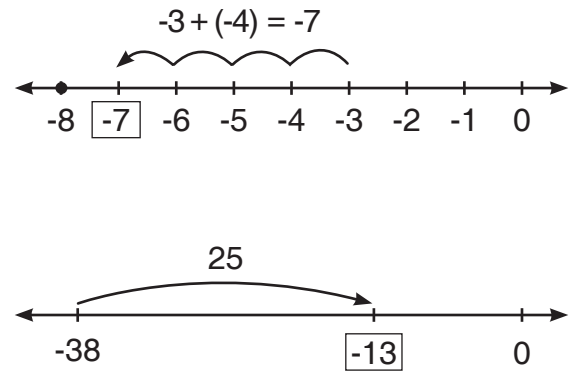

Beast Academy 4

Chapter 10: Fractions (\times & \div)

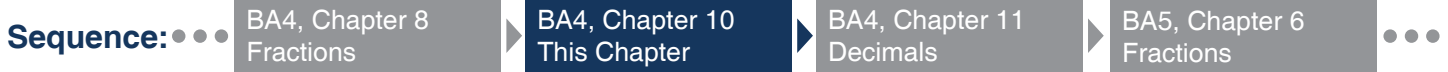

It is very important that students begin this chapter with a firm understanding of fractions as presented in the previous fractions chapters listed above. Before beginning, students should be able to fluently:

- convert between fractions and mixed numbers,
- label and order fractions and mixed numbers on the number line, and
- add and subtract fractions with like denominators.

Overview

This chapter introduces multiplying whole numbers by fractions (like $3 \times \frac{2}{5}$) and division by a unit fraction (like $5 \div \frac{1}{3}$ or $9 \div \frac{1}{11}$). We avoid multiplying fractions (for example, $\frac{2}{5} \times \frac{3}{7}$) and mixed numbers until BA5 Chapter 6.

While the algorithm for multiplying fractions is easy to describe (multiply across the top and across the bottom), students often learn it without understanding. This leads them to mis-apply it. For example, students will add fractions by just adding across the top and bottom.

In this chapter, we help students understand what it means to multiply or divide by a fraction.

“Of”

The word “of” often means “multiply.” For example, we can model 4×15 as “4 groups of 15.” Similarly, $\frac{1}{3} \times 15$ means “ $\frac{1}{3}$ of 15.” To find $\frac{1}{3}$ of 15, we split 15 into three equal parts (thirds). Each part is 5. So, $\frac{1}{3}$ of 15 is 5.

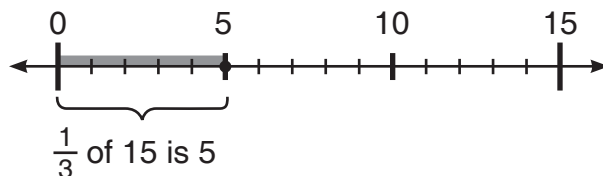

Since $\frac{1}{3} \times 15$ means $\frac{1}{3}$ of 15, we know $\frac{1}{3} \times 15 = 5$. Finding fractions of whole numbers helps students develop intuition for what it means to multiply by a fraction, and they can reason through problems without applying any formulas. Later, when they learn the formulas, the formulas make sense.

Multiply $\frac{5}{6} \times 24$.

First, I can find *one* sixth of 24, which is 4.

Five sixths of 24 is 5 times as much: $5 \times 4 = 20$.

So, $\frac{5}{6} \times 24 = 20$.

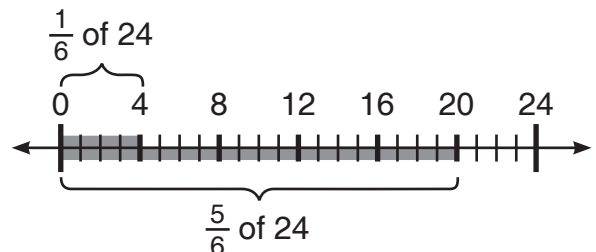

Number lines and other visual models help students gain number sense for fraction multiplication. For example, students can recognize that $\frac{5}{6} \times 24$ has to be a little less than 24. Students who only learn to compute $\frac{5}{6} \times 24$ as $\frac{5 \times 24}{6} = \frac{120}{6} = 20$ don't gain the same fundamental understanding.

Beast Academy 4

Chapter 10: Fractions (\times & \div)

Multiplication

Even though they're equal, we think of $\frac{2}{7} \times 4$ and $4 \times \frac{2}{7}$ differently. We think of $\frac{2}{7} \times 4$ as " $\frac{2}{7}$ of 4," while $4 \times \frac{2}{7}$ means "4 copies of $\frac{2}{7}$."

Finding $\frac{2}{7}$ of 4 is hard to visualize on the number line. But, students can add 4 copies of $\frac{2}{7}$:

$$\begin{aligned}4 \times \frac{2}{7} &= \frac{2}{7} + \frac{2}{7} + \frac{2}{7} + \frac{2}{7} \\ &= \frac{2+2+2+2}{7} \\ &= \frac{8}{7}.\end{aligned}$$

Students can see that $4 \times \frac{2}{7}$ gives us $\frac{4 \times 2}{7}$. We can multiply any whole number by a fraction this way.

And since we can multiply numbers in any order, there are lots of ways we can rewrite fraction multiplication. All four of the expressions below are equal.

$$4 \times \frac{2}{7} = \frac{4 \times 2}{7} = \frac{2 \times 4}{7} = \frac{2}{7} \times 4$$

Manipulating fractions this way can make many fraction multiplication problems easier to compute.

$$\begin{aligned}18 \times \frac{7}{9} &= \frac{18 \times 7}{9} \\ &= \frac{18}{9} \times 7 \\ &= 2 \times 7 \\ &= 14\end{aligned}$$

Here, we pair the 18 with the 9 and simplify $\frac{18}{9}$ to avoid multiplying 18×7 .

Be careful introducing shortcut cross-out strategies that can lead to common mistakes like crossing out factors when adding or subtracting fractions.

Division

Model division problems with examples students can reason through. Start with division by a unit fraction (like $\frac{1}{4}$ or $\frac{1}{9}$).

How many $\frac{1}{4}$ -pound hamburger patties can be made with 5 pounds of beef?

Since you can make 4 patties with every pound, 5 pounds will make $5 \times 4 = 20$ patties.

If the patties were $\frac{1}{3}$ -pound each, you could make 3 patties per pound. So, we'd multiply by 3.

The goal is to give students the intuition that to divide by a unit fraction, we multiply by its reciprocal.

The **reciprocal** of a number is the number you multiply it by to get 1. For example, the reciprocal of $\frac{1}{6}$ is 6, since $\frac{1}{6} \times 6 = 1$. For any fraction $\frac{a}{b}$, the reciprocal is $\frac{b}{a}$, since $\frac{a}{b} \times \frac{b}{a} = \frac{ab}{ab} = 1$.

To divide by any number, we can multiply by its reciprocal. So, to divide by $\frac{1}{3}$, we multiply by 3, and to divide by $\frac{1}{11}$, we multiply by 11.

Beast Academy 4

Chapter 11: Decimals

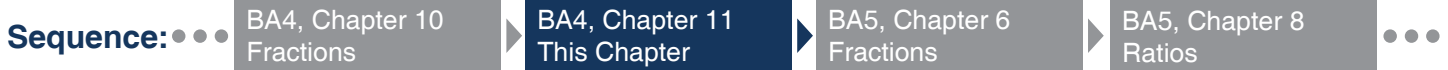

This is the first time we introduce decimals in Beast Academy. Students should already be familiar with fractions.

Overview

Decimals are just another way to write fractions. We emphasize a place value understanding of decimals. Everything students already know about numbers can be extended to these smaller place values. Avoid tricks that hide a place value understanding of decimals.

Place Value

Place value is key to understanding how decimals and fractions relate.

In our number system, each place value is ten times the place value to its right (and ten times smaller than the place value to its left). To the right of the 1's place, we have the $1 \div 10 = \frac{1}{10}$'s (tenths) place, followed by the hundredths place, thousandths place, and so on.

The decimal point is always between the ones place and the tenths place.

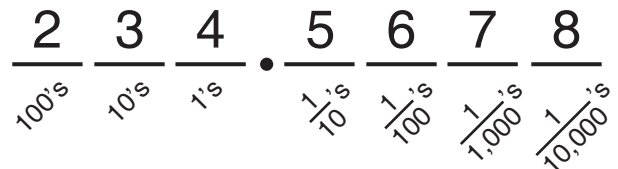

Converting Between Decimals and Fractions

Encourage students to use what they know about place value and equivalent fractions to convert between fractions and decimals.

For example, to write $\frac{453}{1,000}$ as a decimal, we can split it into parts, similar to the way we split whole numbers into ones, tens, and hundreds.



$$\begin{aligned}\frac{453}{1,000} &= \frac{400}{1,000} + \frac{50}{1,000} + \frac{3}{1,000} \\ &= \frac{4}{10} + \frac{5}{100} + \frac{3}{1,000}\end{aligned}$$

So, $\frac{453}{1,000}$ is 4 tenths, 5 hundredths, and 3 thousandths, which we write in decimal form as 0.453.

We can reverse this to convert 0.453 to $\frac{453}{1,000}$.

With practice, students should see that any 3-digit number after the decimal point is a number of thousandths.

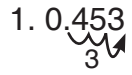
Avoid This

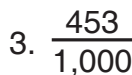
- To convert 0.453 to a fraction, we count the digits right of the decimal point (3).

- Write this number of zeros after a 1 in the bottom of the fraction.

- Write the number in the decimal on top.

Beast Academy 4

Chapter 11: Decimals

Comparing and Ordering

Again, focus on place value. Students who rely on patterns they used to compare whole numbers may make some common mistakes.

Where the digits are is more important than what the digits are.

Even though 4 is larger than 3, students should recognize that 0.04 is less than 0.3. They can write both as fractions and compare, but should eventually recognize that digits in the larger place value always outweigh those in smaller place values.

Having more digits does not always make a number larger.

Guide students to understand why 7.8 is greater than 7.77 with questions like, “Which decimal has more ones? More tenths? Can you write each fraction as a number of hundredths?”

Guide them to understand trailing zeros with questions like, “Which is greater, 0.9 or 0.90?” Trailing 0’s don’t change a decimal’s value.

Align by place value.

It’s easiest to order decimals if their decimal points and all of their place values are aligned. This way, we can compare the digits in the largest place values first.

It may help students to add trailing zeros to make comparing decimals similar to comparing whole numbers. But the goal is for students to compare decimals without adding trailing zeros.

Which is greater,
0.04 or 0.3?

$$0.04 = \frac{4}{100}$$

$$0.3 = \frac{3}{10} = \frac{30}{100}$$

$$\frac{4}{100} < \frac{30}{100}, \text{ so } 0.04 < 0.3.$$

Which is greater,
7.8 or 7.77?

7.8 and 7.77 have the same number of ones, but 7.8 has more tenths, so $7.8 > 7.77$.

Order 0.2, 0.22, 0.202, and 0.022 from greatest to least.

greatest	0.220
↓	0.202
↓	0.200
least	0.022

Addition and Subtraction

Once again, focus on place value. Adding and subtracting decimals is no different from adding and subtracting whole numbers. Align place values and add or subtract the smaller place values first, regrouping or breaking as necessary.

Encourage students to apply the same **mental strategies** they have used with whole numbers to decimal addition and subtraction.

For example, to add $0.75 + 3.4 + 1.25$, we first add $0.75 + 1.25$ to get 2, then add $2 + 3.4$ to get 5.4.

To subtract 2.98 from 8.92, we can subtract 3, then add back 0.02.

Compute $9.53 + 6.7$
and $9.6 - 5.83$.

1	15
9.53	8 10
+ 6.70	0.60
<hr/> 16.23	<hr/> 3.77

$$\begin{array}{l} \text{Compute} \\ 0.75 + 3.4 + 1.25 \\ \hline 0.75 + 3.4 + 1.25 \\ = (0.75 + 1.25) + 3.4 \\ = 2 + 3.4 \\ = 5.4 \end{array}$$

$$\begin{array}{l} \text{Compute} \\ 8.92 - 2.98 \\ \hline 8.92 - 2.98 \\ = 8.92 - 3 + 0.02 \\ = 5.92 + 0.02 \\ = 5.94 \end{array}$$

Beast Academy 4

Chapter 12: Probability

Sequence: BA4, Chapter 4
Counting

BA4, Chapter 12
This Chapter

It is critical that students complete the Counting chapter (BA4 Chapter 4) before beginning. Most of the probability problems in this chapter rely on counting skills. Students must also have a basic understanding of fractions including simplification and some basic addition and subtraction.

Overview

This is a topic that is often not covered until middle school. However, it's one where students can apply a mix of skills from other chapters to solve problems that students usually find interesting. There are too many problem types in the chapter to include in this overview, so we touch on some of the critical concepts students should understand here.

Counting Review

We begin by reviewing some critical counting strategies. Students should be able to:

- Count items in a list. "How many odd numbers are between 100 and 250." (75)
- Count arrangements. "How many different ways can four students stand in line?" (24)
- Count possibilities. "How many 3-digit numbers use only odd digits?" (125)
- Count pairs. "How many ways are there to pick 2 of 10 available pizza toppings?" (45)

Students who can't answer these questions won't be able to answer the probability questions that require these counting skills.

Basics

Probability describes how likely an event is to happen. We usually express the probability of an event as a fraction between 0 (impossible) and 1 (inevitable). For an event where all of the outcomes are equally likely, probability is expressed as:

$$\frac{\text{Number of Desired Outcomes}}{\text{Number of Possible Outcomes}}$$

For example, we can find the probability of rolling a perfect square with the toss of a single die as:

$$\frac{\text{Ways to roll a perfect square (1, 4)}}{\text{Total possible rolls (1, 2, 3, 4, 5, 6)}} = \frac{2}{6} = \frac{1}{3}$$

Since 2 of the 6 possible outcomes give a perfect square, the probability is $\frac{2}{6}$, which simplifies to $\frac{1}{3}$.

When counting outcomes, it's important that all of the outcomes are equally likely. For example, even though there are only 3 numbers on the spinner shown, the probability of spinning a 1 is **not** $\frac{1}{3}$.

But, we can split the spinner into 6 equal areas so that each area is equally likely. Since 3 of these 6 areas contains a 1, the probability of spinning a 1 is actually $\frac{3}{6} = \frac{1}{2}$.

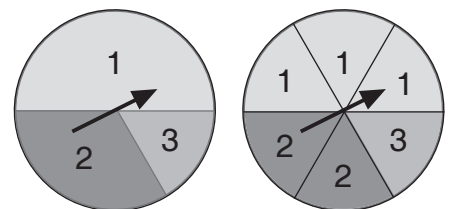

Beast Academy 4

Chapter 12: Probability

Experimenting with Coins

Coins give us an easy way to explore probability. Have students make predictions and test them.

*“If we flip a pair of coins 60 times, how will they land most often?
Two heads, two tails, or one of each?”*

Are all of these outcomes equally likely? If students flip enough times, they should notice that flipping one of each happens much more often than flipping two heads or two tails. The more flips they make, the more likely they are to notice. A sample result is given below. Why is one of each more common?

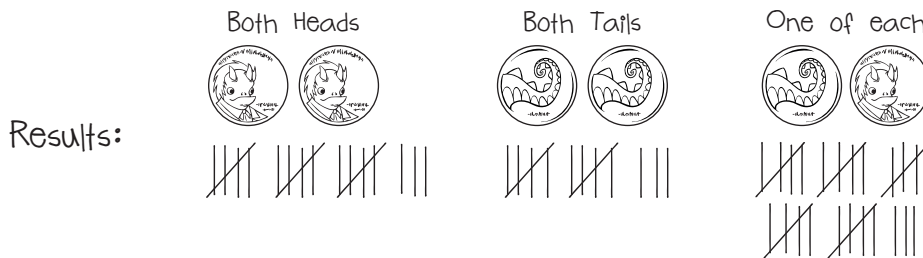

Flipping one of each happens about twice as often because there are actually **two** ways to flip one of each. The first coin can land heads and the second tails. Or, the first coin can land tails and the second heads. This is easiest to see if the coins are obviously different, like a nickel and a dime. All four possibilities (HH, TT, HT, and TH) are equally likely. So, we expect to flip each with $\frac{1}{4}$ probability.

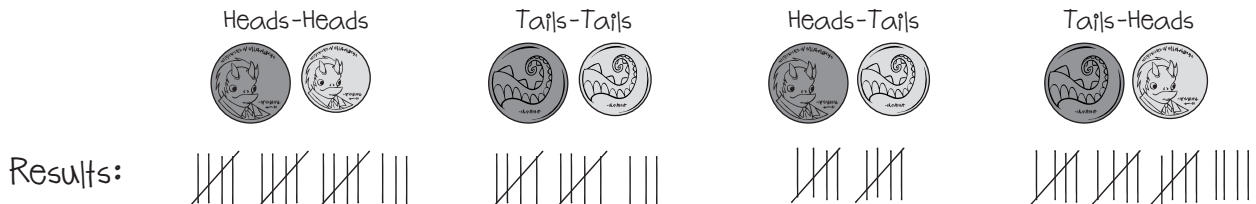

It's unlikely that if you flip a pair of coins 60 times, you'll flip exactly 15 of each possibility above. Probability makes predictions, but doesn't guarantee anything. Even an event that is very unlikely still has a chance. For example, it's *possible* that all 60 flips will land with one heads and one tails. However, the probability of that happening is $\frac{1}{2^{60}} = \frac{1}{1,152,921,504,606,846,976}$. So, it's a pretty safe bet that if someone does it, they're cheating.

Independent and Dependent Events

When you flip a coin, each flip is **independent** of the other flips. None of the flips affect the others. It's common (and natural) to think that if you flip 3 heads in a row, tails is “due” and more likely to happen. But the probability of flipping tails on a *fair* coin will always be $\frac{1}{2}$, no matter what has happened before. The coin doesn't know how it landed the last ten times you flipped it!

But, some events are **dependent** on what has happened before. The easiest examples of this involve drawing an item and not replacing it. For example, the probability of drawing an Ace from a 52-card deck is $\frac{4}{52} = \frac{1}{13}$. But, if you keep the Ace, only 3 of the remaining 51 cards will be Aces. So, the probability of drawing a second Ace is just $\frac{3}{51} = \frac{1}{17}$.